

Stability Analysis of Twin Axial Groove Hybrid Journal Bearing

V. K. Dwivedi^{1†}, S. Chand² and K. N. Pandey¹

¹Department of Mechanical Engineering, Motilal Nehru National Institute of Technology, Allahabad, 211004, India

²Department of Mechanical Engineering, Vishveshwarya Group of Institutions, G.B. Nagar, 203207, India

†Corresponding Author Email: vijay_mirz@yahoo.com

(Received April 30, 2015; accepted March 10, 2016)

ABSTRACT

Stability of rigid rotor supported on hybrid journal bearing with twin axial groove has been investigated using stiffness and damping coefficients of the bearings. In this paper the stability analysis of twin axial groove bearing is determined in different fluid flow regime. Non linear journal centre trajectories are drawn for small amplitude oscillations of the journal centre about its steady state position. It was observed that turbulence decreases 10 to 12 percent the stability margin of twin grooved journal bearings.

Keywords: Stability; Groove; Bearing; Laminar flow; Super laminar.

NOMENCLATURE

a	length of groove	M _c	critical mass of bearing
\bar{C}_{ij}	non dimensionless damping coefficient	S _n	Sommerfeld number
D	diameter of bearing	W	width of groove
i, j	co-ordinate system used in analysis	X _j , Z _j	instantaneous journal centre co-ordinates
\bar{K}_{ij}	non dimensionless spring coefficient	\dot{X}_j, \dot{Z}_j	journal centre velocity
L	length of bearing	α_g	location of groove
M	mass of bearing		

1. INTRODUCTION

Stability is invariably an important consideration in most high speed rotating machinery. Motion trajectory of journal centre in the wake of a disturbance from the equilibrium position can give more insight into the dynamic behavior of a journal bearing system than a mathematical criterion that simply determines if a system is stable or unstable [6]. Morton *et al.* (1987) presented the influence of grooves in bearing on the stability and response of rotating systems. They found that grooved bearing modify the journal locus by increasing the attitude angle and it also change the cavitation boundary at low eccentricity ratios i.e. high speeds. Pai and Mazumdar (1991) analyzed the stability characteristics of submerged plain journal bearings under a unidirectional constant load and variable rotating load. They solved unsteady Reynolds equation by a finite difference method with a successive over relaxation scheme to obtain the

hydrodynamic forces. Using these forces, the equations of motion were solved by the fourth-order Runge-Kutta method to predict the transient behavior of the rotor. Finally, they obtained journal centre trajectories for different operating conditions. It was that at the inlet, flow into the bearing takes place only in the unloaded region. At the outlet, flow takes place out of the bearing in the loaded region.

Das *et al.* (2005) presented the dynamic characteristics of hydrodynamic journal bearings lubricated with micropolar fluids. They concluded that higher threshold of stability is achieved in micropolar lubrication as compared to Newtonian lubrication. The threshold of stability gradually improves with more micropolar effect and the nonlinear analysis provides better stability than the linear analysis. Navthar and Halegowda (2010) presented a method to determine the synchronous whirl i.e. stability of hydrodynamic journal bearings by using dynamic characteristics such as stiffness

coefficients. They found out that bearing operating at a speed of 800 rpm and 150N load remains stable up to a speed of 1666 rpm. They also verified stability of bearing experimentally on journal bearing test rig by operating the bearing up to 1666 rpm. The present paper deals with an investigation on the stability of two axial groove bearing. Results are presented in terms of the journal centre trajectory at constant speed for various Reynolds number and Sommerfeld number. Boukhelef *et al.* (2011) had done dynamic characterization and stability analysis of hydrodynamic bearing using FEM technique. They concluded that stability margin is decreases with increase in slenderness ratio (L/D). Brito *et al.* (2012) presented a comparison of the performance of journal bearing with single and a twin axial groove journal bearing. They found that under heavy loaded operation the twin groove configuration deteriorate the bearing performance when compared with the single groove arrangement due to uneven lubricant feed through each groove. Bhagat and Roy (2014) had done steady state thermo hydrodynamic analysis of two axial groove and multilobe hydrodynamic bearing. They have solved the Reynolds equation along with the energy equation and heat conduction equation in the gap between bush and shaft. Solghar *et al.* (2015) investigated thermo-hydrodynamics characteristics of two axial groove journal bearing by means of computational fluid dynamics technique. They concluded that the proposed model was able to accurately predict the temperature profile of twin groove plain hydrodynamic journal bearing, particularly in the inactive portion of the bearing and in the vicinity of grooves. Ren and Feng (2016) presented a stability margin of the hybrid water lubricated journal bearings for fuel cell vehicle compressor. They also validated their result with experiments.

2. STABILITY ANALYSIS

Referring to Fig 1 the linearized equation of motion for zero unbalance was given in Eq. (1a) and Eq. (1b).

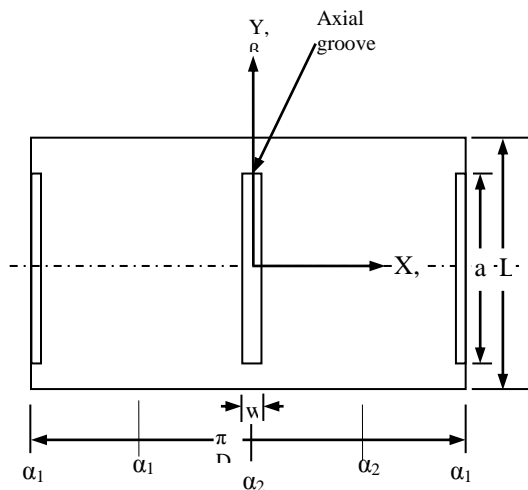

Fig. 1. Fluid domain (unwrapped bearing geometry) including coordinate system.

$$\bar{M}\bar{X}_j + \bar{C}_{xx}\bar{X}_j + \bar{C}_{xz}\bar{Z}_j + \bar{K}_{xx}\bar{X}_j + \bar{K}_{xz}\bar{Z}_j = 0 \quad 1(a)$$

$$\bar{M}\bar{Z}_j + \bar{C}_{zx}\bar{X}_j + \bar{C}_{zz}\bar{Z}_j + \bar{K}_{zx}\bar{X}_j + \bar{K}_{zz}\bar{Z}_j = 0 \quad 1(b)$$

Now let $\bar{X}_j = X_j e^{\lambda t}$ and $\bar{Z}_j = Z_j e^{\lambda t}$

where X_j and Z_j are amplitude of vibration. λ is the frequency.

where,

$$\bar{X}_j = \lambda \bar{X}_1 e^{\lambda t}, \bar{Z}_j = \lambda \bar{Z}_1 e^{\lambda t}, \bar{X}_j = \lambda^2 \bar{X}_1 e^{\lambda t}$$

and $\bar{Z}_j = \lambda^2 \bar{Z}_1 e^{\lambda t}$ in X and Z directions.

Substituting \bar{X}_j , \bar{Z}_j and \bar{X}_j in Eq. (1a), then equation of motion in X direction is given by

$$\bar{M}\lambda^2 \bar{X}_1 e^{\lambda t} + \bar{C}_{xx}\lambda \bar{X}_1 e^{\lambda t} + \bar{C}_{xz}\lambda \bar{Z}_1 e^{\lambda t} + \bar{K}_{xx}\bar{X}_1 e^{\lambda t} + \bar{K}_{xz}\bar{Z}_1 e^{\lambda t} = 0$$

or

$$\bar{M}\lambda^2 \bar{X}_1 + \bar{C}_{xx}\lambda \bar{X}_1 + \bar{C}_{xz}\lambda \bar{Z}_1 + \bar{K}_{xx}\bar{X}_1 + \bar{K}_{xz}\bar{Z}_1 = 0$$

$$(\bar{M}\lambda^2 + \bar{C}_{xx}\lambda + \bar{K}_{xx})\bar{X}_1 + (\lambda \bar{C}_{xz} + \bar{K}_{xz})\bar{Z}_1 = 0 \quad 2(a)$$

Similarly substituting the \bar{X}_j , \bar{Z}_j and \bar{X}_j in Eq. (1b), then equation of motion in Z direction is given by

$$(\lambda \bar{C}_{zx} + \bar{K}_{zx})\bar{X}_1 + (\bar{M}\lambda^2 + \bar{C}_{zz}\lambda + \bar{K}_{zz})\bar{Z}_1 = 0 \quad 2(b)$$

Equations (2a) and Eq. (2b) can be written in matrix form as

$$\begin{pmatrix} \bar{M}\lambda^2 + \bar{C}_{xx}\lambda + \bar{K}_{xx} & (\lambda \bar{C}_{xz} + \bar{K}_{xz}) \\ (\lambda \bar{C}_{zx} + \bar{K}_{zx}) & (\bar{M}\lambda^2 + \bar{C}_{zz}\lambda + \bar{K}_{zz}) \end{pmatrix} \begin{pmatrix} \bar{X}_1 \\ \bar{Z}_1 \end{pmatrix} = 0 \quad (3)$$

For non trivial solution of above equation, the determinant of above matrix should be zero, i.e.

$$\begin{vmatrix} \bar{M}\lambda^2 + \bar{C}_{xx}\lambda + \bar{K}_{xx} & \bar{C}_{xz} + \bar{K}_{xz} \\ \bar{C}_{zx} + \bar{K}_{zx} & \bar{M}\lambda^2 + \bar{C}_{zz}\lambda + \bar{K}_{zz} \end{vmatrix} = 0$$

So, characteristics equation can be written as follows

$$(\bar{M}\lambda^2 + \bar{C}_{xx}\lambda + \bar{K}_{xx})(\bar{M}\lambda^2 + \bar{C}_{zz}\lambda + \bar{K}_{zz}) - (\lambda \bar{C}_{zx} + \bar{K}_{zx})(\lambda \bar{C}_{xz} + \bar{K}_{xz}) = 0$$

Dividing above equation by M^2 , then

$$\lambda^4 \frac{1}{M} (\bar{C}_{xx} + \bar{C}_{zz}) \lambda^3 + \frac{1}{M^2} [\bar{C}_{xx}\bar{C}_{zz} - \bar{C}_{xz}\bar{C}_{zx} + M(\bar{K}_{xx} + \bar{K}_{zz})] \lambda^2 + \frac{1}{M^2} (\bar{C}_{xx}\bar{K}_{zz} + \bar{C}_{zz}\bar{K}_{xx} - \bar{C}_{xz}\bar{K}_{zx} - \bar{C}_{zx}\bar{K}_{xz}) \lambda + \frac{1}{M^2} (\bar{K}_{xx}\bar{K}_{zz} - \bar{K}_{xz}\bar{K}_{zx}) = 0 \quad (4)$$

$$\text{or, } \lambda^4 + a_1 \lambda^3 + a_2 \lambda^2 + a_3 \lambda + a_4 = 0 \quad (5)$$

where,

$$\begin{aligned}
 a_1 &= \frac{1}{M}(\bar{C}_{xx} + \bar{C}_{zz}) \\
 a_2 &= \frac{1}{M^2}[\bar{C}_{xx}\bar{C}_{zz} - \bar{C}_{xz}\bar{C}_{zx} + M(\bar{K}_{xx} + \bar{K}_{zz})] \\
 a_3 &= \frac{1}{M^2}(\bar{C}_{xx}\bar{K}_{zz} + \bar{C}_{zz}\bar{K}_{xx} - \bar{C}_{xz}\bar{K}_{zx} - \bar{C}_{zx}\bar{K}_{xz}) \\
 a_4 &= \frac{1}{M^2}(\bar{K}_{xx}\bar{K}_{zz} - \bar{K}_{xz}\bar{K}_{zx})
 \end{aligned}$$

For stability analysis of linearized system given by Eq. (2a) and Eq. (2b), Routh-Herwitz criteria is employed on characteristic equation, Eq. (5) and is given in Table 1.

Table 1 Routh's tabulation for characteristic Eq. (5)

λ^4	1	a ₂	a ₄
λ^3	a ₁	a ₃	0
λ^2	$\frac{a_1 a_2 - a_3 \times 1}{a_1}$	$\frac{a_1 a_4 - 0 \times 1}{a_1}$	0
λ^1	$\frac{\left(\frac{a_1 a_2 - a_3}{a_1}\right) - a_1 a_4}{\frac{a_1 a_2 - a_3}{a_1}}$	0	0
λ^0	a ₄	0	0

According to Routh-Herwitz criteria of stability, the first and second row element of Routh's tabulation table should be positive and all the element of first column should be positive.

So from first condition of Routh-Herwitz criteria

$$a_1, a_2, a_3, a_4 > 0 \tag{6}$$

From second criteria of Routh criteria

$$a_1 a_2 - a_3 > 0 \tag{7}$$

$$\text{or, } \frac{\left(\frac{a_1 a_2 - a_3}{a_1}\right) - a_1 a_4}{\frac{a_1 a_2 - a_3}{a_1}} > 0$$

$$\text{or, } a_1 a_2 a_3 - a_1^2 a_4 > 0 \tag{8}$$

Substituting values of a_1, a_2, a_3 in Eq. (8)

$$\begin{aligned}
 &\frac{1}{M}(\bar{C}_{xx} + \bar{C}_{zz}) \frac{1}{M^2}[\bar{C}_{xx}\bar{C}_{zz} - \bar{C}_{xz}\bar{C}_{zx} + M(\bar{K}_{xx} + \bar{K}_{zz})] \\
 &\frac{1}{M^2}(\bar{C}_{xx}\bar{K}_{zz} + \bar{C}_{zz}\bar{K}_{xx} - \bar{C}_{xz}\bar{K}_{zx} - \bar{C}_{zx}\bar{K}_{xz}) \\
 &- \left\{ \frac{1}{M^2}(\bar{C}_{xx}\bar{K}_{zz} + \bar{C}_{zz}\bar{K}_{xx} - \bar{C}_{xz}\bar{K}_{zx} - \bar{C}_{zx}\bar{K}_{xz}) \right\}^2 \\
 &- \left\{ \frac{1}{M}(\bar{C}_{xx} + \bar{C}_{zz}) \right\}^2 (\bar{K}_{xx}\bar{K}_{zz} - \bar{K}_{xz}\bar{K}_{zx}) > 0 \\
 &\frac{1}{M} \tilde{a}_1, \frac{1}{M^2} \tilde{a}_2, \frac{1}{M^2} \tilde{a}_3 - \frac{1}{M^4} \tilde{a}_3^2 - \frac{\tilde{a}_1^2}{M^2} \cdot \frac{\tilde{a}_4}{M^2} > 0
 \end{aligned}$$

$$\tag{10}$$

where,

$$\begin{aligned}
 \tilde{a}_1 &= \bar{C}_{xx} + \bar{C}_{zz}, \quad \tilde{a}_2 = \tilde{a}_{21} + \tilde{a}_{22}, \\
 \tilde{a}_{21} &= (\bar{C}_{xx}\bar{C}_{zz} - \bar{C}_{xz}\bar{C}_{zx}), \quad \tilde{a}_{22} = M(\bar{K}_{xx} + \bar{K}_{zz}) \\
 \tilde{a}_3 &= \bar{C}_{xx}\bar{K}_{zz} + \bar{C}_{zz}\bar{K}_{xx} - \bar{C}_{xz}\bar{K}_{zx} - \bar{C}_{zx}\bar{K}_{xz} \\
 \tilde{a}_4 &= (\bar{K}_{xx}\bar{K}_{zz} - \bar{K}_{xz}\bar{K}_{zx})
 \end{aligned}$$

so Eq. (10) is rewritten as

$$\tilde{a}_1 \tilde{a}_2 \tilde{a}_3 - M \tilde{a}_3 - M \tilde{a}_1 \tilde{a}_4 > 0$$

$$\text{or, } \tilde{a}_1 \tilde{a}_2 \tilde{a}_3 > M(\tilde{a}_3^2 + \tilde{a}_1 \tilde{a}_4)$$

$$\text{or, } \tilde{a}_1 \cdot (\tilde{a}_{21} + M \tilde{a}_{22}) \cdot \tilde{a}_3 > M(\tilde{a}_3^2 + \tilde{a}_1 \tilde{a}_4)$$

$$\text{or, } M < \frac{\tilde{a}_1 \tilde{a}_{21} \tilde{a}_3}{\tilde{a}_3^2 + \tilde{a}_1 \tilde{a}_4 - \tilde{a}_1 \tilde{a}_{22} \tilde{a}_3} \tag{11}$$

So for critical case the critical mass M_c is equal to right side of Eq. (11) and is given as

$$\begin{aligned}
 M_c &= \frac{\tilde{a}_1 \tilde{a}_{21} \tilde{a}_3}{\tilde{a}_3^2 + \tilde{a}_1 \tilde{a}_4 - \tilde{a}_1 \tilde{a}_{22} \tilde{a}_3} \\
 &= \frac{\tilde{a}_{21}}{\tilde{a}_3^2 + \tilde{a}_1 \tilde{a}_4 - \tilde{a}_1 \tilde{a}_{22} \tilde{a}_3} \\
 &= \frac{\tilde{a}_{21}}{\tilde{a}_1 \tilde{a}_3} \\
 &= \frac{\tilde{a}_{21}}{\tilde{a}_3 + \frac{\tilde{a}_4 \tilde{a}_1}{\tilde{a}_3} - \tilde{a}_{22}} \\
 M_c &= \frac{\tilde{a}_{21}}{\frac{\tilde{a}_4 \tilde{a}_1}{\tilde{a}_3} + \frac{\tilde{a}_{22} \tilde{a}_1}{\tilde{a}_1}} \tag{12}
 \end{aligned}$$

Substituting values of $\tilde{a}_1, \tilde{a}_{21}, \tilde{a}_{22}, \tilde{a}_3, \tilde{a}_4$ in Eq. (12), the critical mass for stability is given by Eq. (13)

$$M_c = \frac{\bar{C}_{xx}\bar{C}_{zz} - \bar{C}_{xz}\bar{C}_{zx}}{\left(\frac{(\bar{C}_{xx} + \bar{C}_{zz})(\bar{K}_{xx}\bar{K}_{zz} - \bar{K}_{xz}\bar{K}_{zx})}{\bar{C}_{xx}\bar{K}_{zz} + \bar{C}_{zz}\bar{K}_{xx} - \bar{C}_{xz}\bar{K}_{zx} - \bar{C}_{zx}\bar{K}_{xz}} - \frac{\bar{K}_{xx}\bar{C}_{xx} + \bar{K}_{zz}\bar{C}_{zz} - \bar{K}_{xz}\bar{C}_{zx} - \bar{K}_{zx}\bar{C}_{xz}}{\bar{C}_{xx} + \bar{C}_{zz}} \right)} \tag{13}$$

From Eq. (13) it is clear that the smaller critical mass secured more stability for all Sommerfeld number.

3. COMPUTATIONAL PROCEDURE

Reynolds equation which governs flow of lubricant in the clearance space of a journal bearing is modified to study the laminar, transition and turbulent flows, by including turbulence coefficients \bar{K}_x and \bar{K}_y . The short bearing

approximation has been used to solve the Reynolds equation. With the short bearing approximation, the closed form expression of pressure distribution has been obtained by integrating twice the Reynolds equation and using boundary conditions. Positive pressure zone was established by deleting sub-ambient pressure. For superlaminar flow, an iterative solution technique was employed for establishing flow regimes; laminar, transition or fully developed turbulent flow.

3.1 Determination of Turbulence Coefficients

To obtain the solution of Reynolds equation and thus the pressure distribution, flow regime and corresponding turbulence coefficients are determined iteratively. Initially flow is assumed to be either laminar or turbulent to get initial value of \bar{K}_x and \bar{K}_y and pressure distribution. From this pressure distribution circumferential, axial and total flow are obtained. After getting total flow, mean Reynolds number is determined and compared to a critical local Reynolds number. After getting modified flow regime new values of turbulence coefficients \bar{K}_x and \bar{K}_y are calculated. This procedure is repeated till difference in the corresponding nodal pressure in two successive iterations are not less than a pre assigned tolerance. After establishing a converged solution for pressure, fluid film reaction forces are computed.

3.2 Journal Centre Equilibrium Position for External Load

Initially a trial value of journal centre co-ordinates X_j and Z_j are chosen and after establishing the extent of fluid film, the film reactions and its derivatives are calculated. Using these values ΔX_j and ΔZ_j are calculated and the new values of X_j and Z_j are obtained. This procedure is repeated until percentage change in eccentricity ratio is not less than a pre assigned tolerance.

3.3 Computation of Fluid Film Thickness and Damping Coefficients

For computation of fluid film stiffness co-efficients, derivatives of fluid film force with respect to the journal centre components \bar{X}_j and \bar{Z}_j are computed numerically. Similarly for computation of fluid film damping coefficients, derivatives of fluid film forces with respect to the journal center velocity components $\dot{\bar{X}}_j$ and $\dot{\bar{Z}}_j$ are computed numerically.

3.4 Transient Motion Trajectory of the Journal Centre

The linear trajectory from the linearized equation of motion and the nonlinear trajectory from the nonlinear equations of motion were obtained, using fourth order Runge-Kutta method. For this procedure, the second order equations of motion were converted into a set of first order equations. In the fourth order Runge-Kutta method, initial disturbance in position and velocities are given. For

time marching solution the process is repeated four times and new position of journal centre is established. Journal centre trajectories were drawn at constant speed of operation with respect of linearized stability chart for both laminar and superlaminar flow conditions as shown in Fig. 4 to Fig 9.

4. RESULT AND DISCUSSION

The analysis and solution algorithm were used to compute the static and dynamic performance characteristics and to obtain transient motion trajectories. The motion trajectories were obtained for both, constant speed and accelerating/decelerating journals for the plain circular hydrodynamic journal bearing operating in laminar and super laminar flow conditions. These studies were conducted by taking bearing aspect ratio (L/D) 0.25 and 0.5. Transient

analysis was particularly done for 0.5 aspect ratio, assuming bearing and journal axes parallel and ratio of nominal clearance to the journal radius 0.001 (C/R = 0.001).

To establish the validity of the analysis, solution algorithms and the computer program, the eccentricity ratio obtained from the present short bearing approximation were compared with finite and short bearing results available in Capone *et al.* (1987). In Fig 2, the comparison of eccentricity ratio are shown for laminar and superlaminar flow conditions of fluid film at L/D ratio of 0.25 between present short bearing analysis and the results of Capone *et al.* (1987). The obtained results are within the acceptable range of limit.

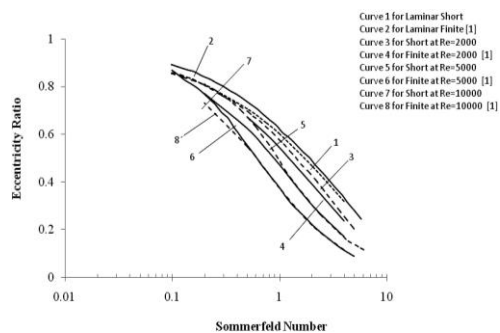

Fig. 2. Eccentricity vs. Sommerfeld Number for L/D = 0.25 for variation of Reynolds number.

Linearized stability analysis of the twin grooved journal bearing system is shown in Fig 3 in terms of stability chart under laminar and superlaminar flow conditions of the lubricant. It is clear from Fig 3, turbulence decreases the stability of twin groove journal bearing as compared to non grooved journal bearing. In this figure characteristic speed is plotted against Sommerfeld number for laminar and superlaminar flow conditions of lubricant for twin groove journal bearing system. L/D ratio for this study was taken as 0.5. The obtained trend shows that with the increase in Sommerfeld number, characteristic speed decreases for a particular flow

conditions and becomes independent of Sommerfeld number for high Sommerfeld number for all flow conditions and for both twin grooved and non grooved bearing.

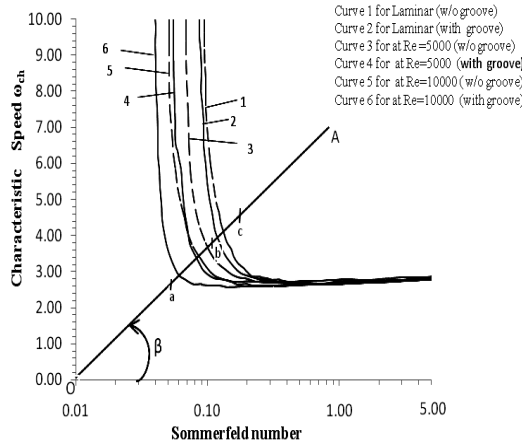

Fig. 3. Comparative study of characteristic speed for groove and non-groove journal bearing.

Journal bearing system is stable if operated to the left of the stability chart and unstable when operated to right of the curve. Curve shift towards left with increase in Reynolds number both for twin grooved and non grooved bearing. Results show that stability increases with decrease in the turbulence level for a particular value of Sommerfeld number. For a particular flow condition of the lubricant, stability curve shifts left for twin grooved bearing in comparison to non grooved bearing showing reduction in stability margin.

To validate the stability results of linearized analysis, nonlinear journal centre trajectories were drawn for laminar and superlaminar flow conditions along β -line 'OA' shown in Fig 3. Sommerfeld numbers corresponding to different operating points taken along OA line are given in Table 2.

Table 2 Sommerfeld number corresponding to different operating point along OA line of Fig. 3

Operating point	a	b	c
Sommerfeld No.	0.053	0.11	0.17

Journal centre trajectories as shown in Fig 4 to 9 are obtained at constant speed of operation with disturbance in displacement ΔX_j and ΔZ_j equal to 0.005. Disturbance in velocities $\Delta \dot{X}_j$ and $\Delta \dot{Z}_j$ was taken as zero. The operating points are 'a', 'b' and 'c' corresponding to three different flow zones of laminar and super laminar flow regimes.

At point 'a' the journal is stable for both laminar and super laminar flow conditions as shown in Fig 4 and Fig 5. At the point 'b' the journal is stable (Fig 6) when the turbulent effects are neglected but unstable when the turbulent effects are considered, Fig 7. At point 'c' the journal is unstable irrespective of the turbulent effects are considered or not (Fig 8 and Fig 9)

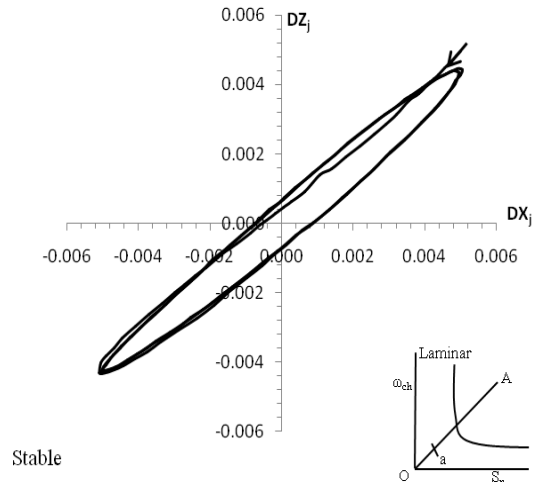

Fig. 4. Nonlinear journal centre trajectory at constant speed along line OA (Laminar flow, L/D = 0.5, Sn = 0.053, at point 'a').

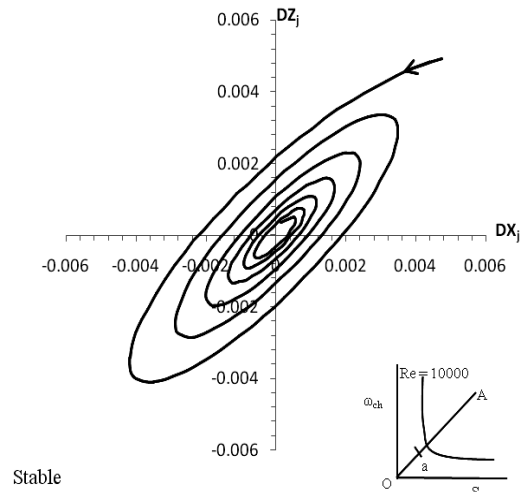

Fig. 5. Nonlinear journal centre trajectory at constant speed along line OA (Re = 10000, L/D = 0.5, Sn = 0.053, at point 'a').

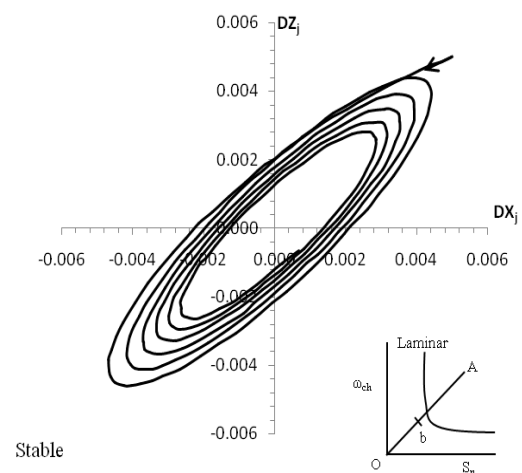

Fig. 6. Nonlinear journal centre trajectory at constant speed along line OA (Laminar flow, L/D = 0.5, Sn = 0.11, at point 'b').

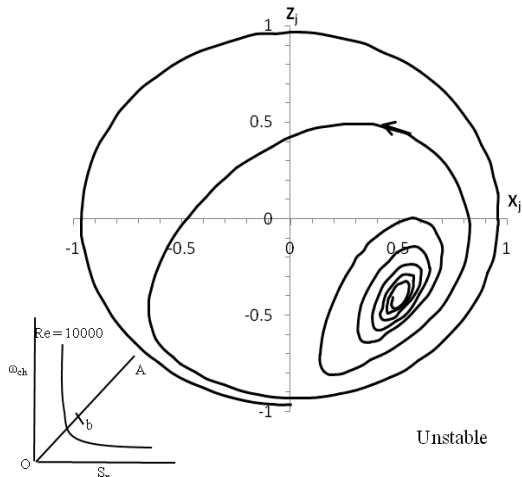

Fig. 7. Nonlinear journal centre trajectory at constant speed along line OA ($Re=10000$, $L/D = 0.5$, $S_n = 0.11$, at point 'b').

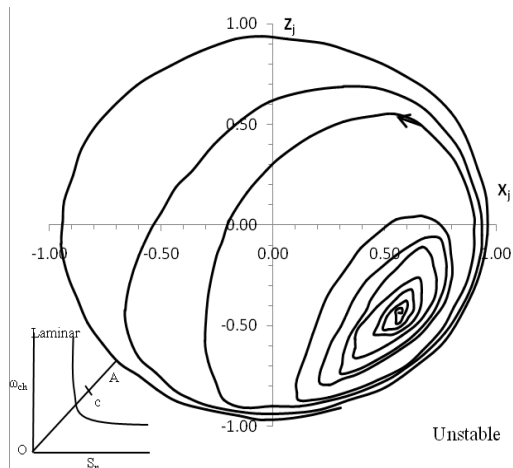

Fig. 8. Nonlinear journal centre trajectory at constant speed along line OA, Laminar flow, $L/D = 0.5$, $S_n = 0.17$, at point 'c'.

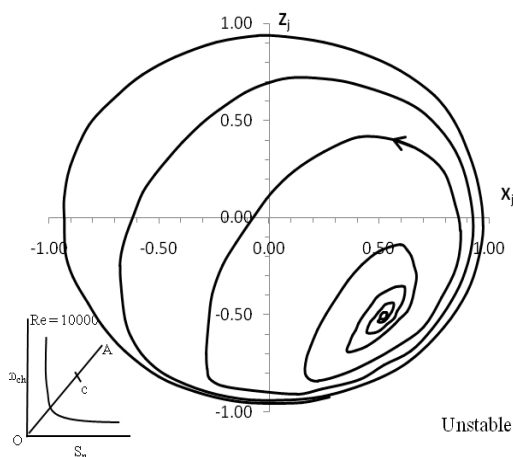

Fig. 9. Nonlinear journal centre trajectory at constant speed along line OA, $Re = 10000$, $L/D = 0.5$, $S_n = 0.17$, at point 'c'.

5. CONCLUSION

Turbulence decreases 10 to 12 percent of the stability margin of twin groove journal bearing similar to cylindrical non grooved bearing. Linearized stability curve shifts leftward on the stability chart with increase in Reynolds number, reducing the stability margin. Non linear analysis done in terms of journal centre trajectories verifies the linearized analysis.

REFERENCES

- Bhagat, C. and L. Roy (2014). Steady state thermo-hydrodynamic analysis of two axial groove and multilobe hydrodynamic bearings. *Tribology in Industry* 36(4), 475-487.
- Boukhelef, D., A. Bounif and D. A. Bouzid (2011). Dynamic characterization and stability analysis of hydrodynamic journal bearing using FEM. *Mechanica* 17(5), 503-509.
- Brito, F. P., A. S. Miranda, J. C. P. Claro and M. Fillon (2012). Experimental comparison of the performance of a journal bearing with a single and twin axial groove configuration. *Tribology International* 54, 1-8.
- Capone, G., M. Russo and R. Russo (1987). Dynamic characteristics and stability of a journal bearing in a non-laminar lubrication regime. *Tribology International* 20(5), 255-258.
- Das, S. K., S. K. Guha and A. K. Chattopadhyay (2005). Linear stability analysis of hydrodynamic journal bearings under micropolar lubrication. *Tribology International* 38, 500-507.
- Morton, P. G., J. H. Johnson and M. H. Walton (1987). The influence of grooves in bearing on the stability and response of rotating systems. *Tribology Series* 11, 347-354.
- Navthar, R. R. and N. V. Halegowda (2010). Stability analysis of hydrodynamic journal bearing using stiffness coefficients. *International Journal of Engineering Science and Technology* 2(2), 87-93.
- Pai, R. and B. C. Mazumdar (1991). Stability of submerged oil journal bearings under dynamic load. *Wear* 146(1), 125-135.
- Ren, T. and M. Feng (2016). Stability analysis of water lubricated journal bearing for fuel cell vehicle air compressor. *Tribology International*, 95, 342-348.
- Singh, D. V., R. Sinhasan and S. P. Tayal (1976). Theoretical prediction of journal centre motion trajectory. *Transactions of ASME* 98, 620-628.
- Solghar, A. A., F. P. Brito, M. Abdolzadeh and A. Farajpour (2015). Numerical study of twin groove journal bearings performance under steady state condition. *Lubrication Science* 27(2), 83-102.

